

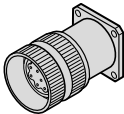

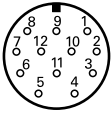













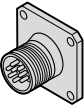

# Electrical connection

## Pin layout of connecting element to the EIB input

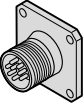

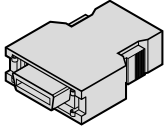
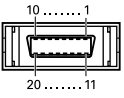



<b>12-pin flange connector, M23</b>   												
	Power supply				Incremental signals						Others	
	<b>12</b>	<b>2</b>	<b>10</b>	<b>11</b>	<b>5</b>	<b>6</b>	<b>8</b>	<b>1</b>	<b>3</b>	<b>4</b>	<b>7</b>	<b>9</b>
	<b>U<sub>P</sub></b>	<b>Sensor U<sub>P</sub></b>	<b>0V</b>	<b>Sensor 0V</b>	<b>A+</b>	<b>A-</b>	<b>B+</b>	<b>B-</b>	<b>R+</b>	<b>R-</b>	/	/
	Brown/ Green	Blue	White/ Green	White	Brown	Green	Gray	Pink	Red	Black	/	/

## Pin layout of connecting element to the EIB output

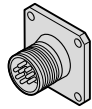
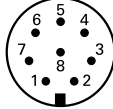
<b>EIB 1512</b>   										
	Voltage supply				Position values					
	<b>8</b>	<b>2</b>	<b>5</b>	<b>1</b>	<b>3</b>	<b>4</b>	<b>7</b>	<b>6</b>		
	<b>U<sub>P</sub></b>	<b>Sensor U<sub>P</sub></b>	<b>0V</b>	<b>Sensor 0V</b>	<b>DATA</b>	<b>DATA</b>	<b>CLOCK</b>	<b>CLOCK</b>		
	Brown/Green	Blue	White/Green	White	Gray	Pink	Violet	Yellow		

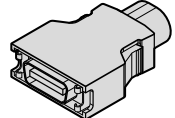
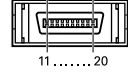
<b>EIB 1592F</b>   										<b>20-pin Fanuc connector</b>   				
	Voltage supply					Position values								
	<b>8</b>	<b>2</b>	<b>5</b>	<b>1</b>	–	<b>3</b>	<b>4</b>	<b>7</b>	<b>6</b>					
	<b>9</b>	<b>18/20</b>	<b>12</b>	<b>14</b>	<b>16</b>	<b>1</b>	<b>2</b>	<b>5</b>	<b>6</b>					
	<b>U<sub>P</sub></b>	<b>Sensor U<sub>P</sub></b>	<b>0V</b>	<b>Sensor 0V</b>	<b>Shield</b>	<b>Serial Data</b>	<b>Serial Data</b>	<b>Request</b>	<b>Request</b>					
	Brown/ Green	Blue	White/Green	White	–	Gray	Pink	Violet	Yellow					

Pin layout of connecting element to the EIB output

EIB 1592M					10 or 20-pin Mitsubishi connector			
<b>8-pin flange socket, M12</b>   					  			
	Voltage supply				Position values			
	8	2	5	1	3	4	7	6
	20	19	1	11	6	16	7	17
	1	-	2	-	7	8	3	4
	$U_P$	Sensor $U_P$	0V	Sensor 0V	Serial Data	Serial Data	Request Frame	Request Frame
	Brown/Green	Blue	White/Green	White	Gray	Pink	Violet	Yellow

**Shield** on housing; **U<sub>P</sub>** = supply voltage

**Sensor:** The sensor line is connected internally with the corresponding power line.

Vacant pins or wires must not be used!

## Cables

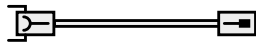
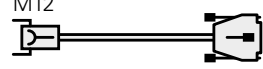
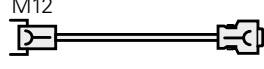
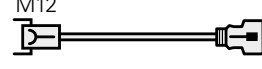
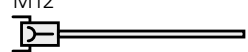
PUR [(4 × 0.14 mm <sup>2</sup> ) + (4 × 0.34 mm <sup>2</sup> )] Ø 6 mm; A <sub>P</sub> = 0.34 mm <sup>2</sup>	EIB 1512	EIB 1592F	EIB 1592M
<b>Connecting cable, complete</b>	ID 368330-xx M12 		
<b>Adapter cable, complete</b>	With D-sub connector (female) ID 524599-xx M12 	With Fanuc connector ID 646807-xx M12 	With Mitsubishi connector 10-pin ID 647314-xx 20-pin ID 646806-xx M12 
<b>Connecting cable with one connector</b>	ID 634265-xx M12 		

A<sub>P</sub>: Cross section of power supply lines

# Configuration of the EIB 1500

In order for the EIB 1500 to function correctly together with the encoder, certain encoder parameters must be stored in the EIB 1500 (such as the number of signal periods, nominal increment of the reference marks, encoder ID, etc.). Only HEIDENHAIN can program this information. This information is also printed on the ID label. It can be read out via the EnDat interface.

## Information on the ID label

The **data interface** designates the type of interface for transmission of the position values at the output of the EIB.

For rotatory encoders the number of **signal periods** per revolution is indicated.

The **encoder ID** indicates the type of encoder that can be connected, e.g.

EnDat 22:

80 Rotational encoders **without** distance-coded reference marks

90 Rotational encoders **with** distance-coded reference marks

For the EnDat interface, this value is stored in word 14 of the EnDat 2.1 parameters.

The **nominal increment N of the reference marks** is indicated in signal periods if the connected encoder has distance-coded reference marks (EnDat 2.2 encoder ID = 90).

## Example

Connection of two ERA scanning heads (line count 16384) over EIB 1512 to the EnDat-2.2 interface.

*Information on the ID label*

Data interface: EnDat22

Encoder ID: 90

Line count and signal period: 16384

Nominal increment

of the reference marks: 2048

Subdivision factor: 16384

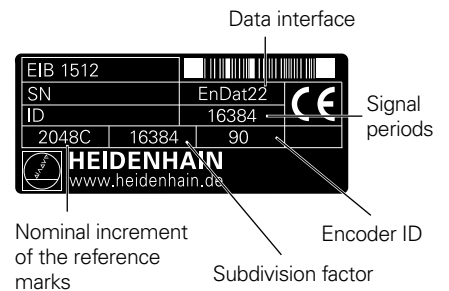

# Connection information

## Establishing the absolute reference

The EIB 1500 must be connected only to incremental encoders with distance-coded reference marks. Immediately after switch-on it provides relative position values that begin with the position upon switch-on. The absolute reference is not established until the reference marks are traversed. Both scanning heads have to move over two successive reference marks without changing direction.

## EIB 1512: Requirements for the control

EnDat 2.2 permanently provides the relative position as Position 1. When the absolute reference is established, the RM bit is set and the absolute position value is transmitted in the EnDat additional data as Position 2. Before you use the EIB 1512, please check whether the subsequent electronics support this EnDat 2.2 device profile for incremental encoders.

### Please note:

It is not possible to combine the EIB 1512 and EIB 2391S, because the EIB 2391S accepts only absolute encoders.

## EIB 1512: Online diagnostics

The EIB 1512 supports the online diagnostics of EnDat 2.2 and provides valuation numbers for the incremental track, reference pulse width and reference pulse position. In each case, the lower value of the two connected encoders is applied. This provides information on the functionality of the total system, but it allows no direct analysis of a single scanning head.

---

# HEIDENHAIN

**DR. JOHANNES HEIDENHAIN GmbH**

Dr.-Johannes-Heidenhain-Straße 5

**83301 Traunreut, Germany**

☎ +49 8669 31-0

FAX +49 8669 5061

E-mail: [info@heidenhain.de](mailto:info@heidenhain.de)

---

**[www.heidenhain.de](http://www.heidenhain.de)**

This Product Information supersedes all previous editions, which thereby become invalid. The basis for ordering from HEIDENHAIN is always the Product Information valid when the contract is made.