



# HEIDENHAIN



**Functional  
Safety**

Product Information

## **EIB 2391 S** External Interface Box

# EIB 2391 S

## External Interface Box with firmware version 15

- **Input:** HEIDENHAIN encoders with EnDat22 interface
- **Output:** DRIVE-CLiQ interface

### Encoder requirements

The EIB 2391 S makes it possible to connect encoders with the ordering designation EnDat22 to the DRIVE-CLiQ interface. The following encoder series (with or without functional safety) are supported:

- Absolute sealed linear encoders, such as:
  - LC 100, LC 400, LC 200
- Absolute exposed linear encoders, such as:
  - LIC 2000, LIC 4000
- Absolute angle encoders, such as:
  - RCN 2000, RCN 5000, RCN 8000
  - ROC 2000, ROC 7000
  - ECA 4000
- Absolute singleturn encoders, such as:
  - ECN 100
  - ECI 100, ECI 1100, ECI 1300
- Absolute multiturn encoders, such as:
  - EQI 1100, EQI 1300
- Length gauges
  - AT 3000
  - AT 1200

In principle, it is possible to connect further encoders featuring the EnDat22 interface depending, however, on the firmware level of the EIB and the subsequent electronics. Please contact HEIDENHAIN or the manufacturer of the subsequent electronics for further information.

The following encoder series with order designation EnDat22 cannot currently be connected to the DRIVE-CLiQ interface and therefore cannot be operated together with the EIB 2391 S:

- Encoders with the "EnDat incremental" profile, such as ERM 2400, LIP 200, EIB 100, EIB 300, EIB 1500
- Encoders with battery-buffered revolution counter, such as EBI 100, EBI 1100, EBI 4000

After switch-on, the EIB tests various characteristics of the connected encoder and automatically adapts itself to it. If the encoder does not meet the necessary requirements, an error message is issued via the DRIVE-CLiQ interface.

### Online diagnostics

With EnDat 2.2 encoders, valuation values can be read cyclically from the encoder to evaluate its functioning. The valuation numbers provide the current state of the encoder and ascertain the encoder's "function reserves." These function reserves are also transmitted via the DRIVE-CLiQ interface and can be displayed in the higher-level control. Further information is available from HEIDENHAIN upon request.

### Temperature sensor information

The EIB 2391 S does not have a temperature sensor input, but it can evaluate the temperature sensor information from connected EnDat encoders and pass it through the DRIVE-CLiQ interface. Up to four types of temperature information can be transmitted. The EIB 2391 S supports transmission from

- an internal temperature sensor (value is provided in the DRIVE-CLiQ parameter "Encoder Temperature")
- up to four external temperature sensors (values are provided in the DRIVE-CLiQ parameter "Motor Temperature," numbered accordingly)

The EIB 2391 S can simultaneously process the information of one external and one internal temperature sensor. If more than one external temperature sensor is used, the value of the internal temperature sensor can no longer be provided.

The evaluation of the connected sensors can be set via the DRIVE-CLiQ interface, depending on the settings of the EnDat encoder. This allows temperature sensors of types KTY 84-130, PT 1000 and PTC to be evaluated. For more information, please contact HEIDENHAIN.

You can find further information on the availability and mapping of the temperature sensor information in the documentation of the connected EnDat encoder.

DRIVE-CLiQ is a registered trademark of Siemens Aktiengesellschaft

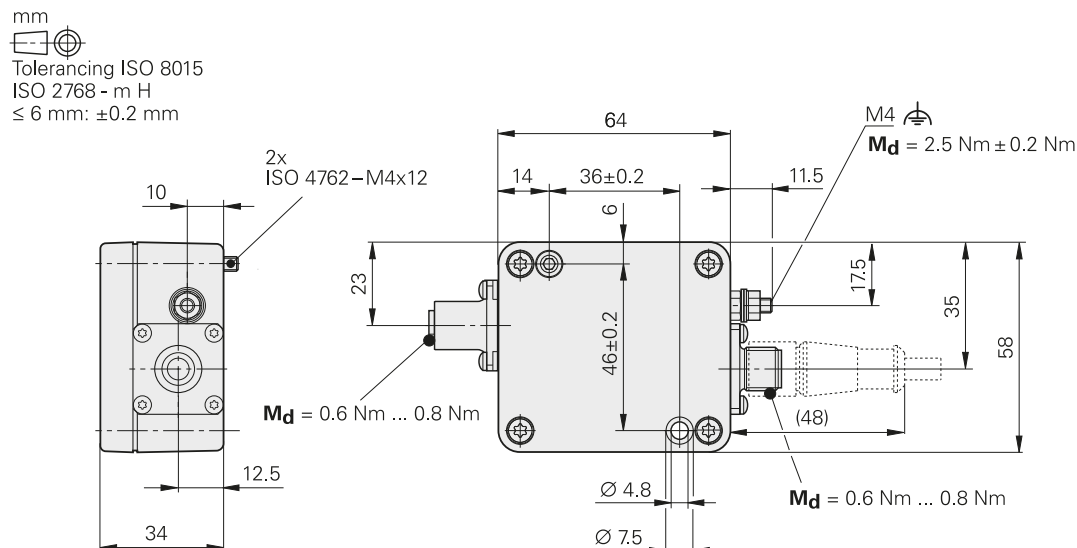

### Firmware versions

Two firmware versions are available for the EIB 2391 S. The firmware version can be read out over the DRIVE-CLiQ parameter "Act\_FW\_Version" (index 0). The last two placed of the displayed value are decisive. The following information is given with reference to these two places.

EIB 2391 S with ID 768200-01

- Delivery with **firmware version 11**
- An update from firmware version 11 to version 15 is possible via the DRIVE-CLiQ series electronics
- A downgrade from **firmware version 15** to version 11 is not permissible
- Will be replaced by EIB 2391 S with ID 768200-02

EIB 2391 S with ID 768200-02

- Delivery with **firmware version 15**
- Replaces the EIB 2391 S with ID 768200-01 because it is backwards compatible

Please note:

A downgrade from firmware version 15 to version 11 is not permissible

### Functional safety

In principle, the EIB can be used in safety-related applications only if functional safety is supported by the connected encoder. The characteristics with regard to functional safety are substantially determined by the connected encoder and the subsequent electronics (if required, contact the manufacturer; the EIB basically conveys the characteristics of the encoder).

The **safe position** is also substantially determined by the connected encoder and the subsequent electronics. The EIB itself does not influence the safe position. The "safe position" and "safety-related measuring step (SM)" of the connected EnDat encoder are required to calculate the safe position. Please contact the manufacturer of the subsequent electronics for further information.

The **PFH value** of the total system (EIB 2391 S + encoder) is the sum of the PFH values of the EIB 2391 S and the connected encoder. For information on the measuring instrument, please refer to the documentation of the encoder (product information document, brochure and mounting instructions).

Please contact the manufacturer of the subsequent electronics for more information on the application of the EIB and encoder in safety-related applications.

### Restrictions

With linear encoders featuring measuring lengths greater than 50 m, there may under certain circumstances be limitations in the output of the commutation angle via the DRIVE-CLiQ interface. Saving a datum shift in the EnDat encoder can also have limitations. Please contact HEIDENHAIN in such cases.

#### NOTE:

The software of the DRIVE-CLiQ subsequent electronics must be designed for operation of the EIB 2391 S in safety-related applications. For more information on availability, please refer to the manufacturer.





Specifications	EIB 2391 S
<b>Functional safety</b>	Depending on the connected encoder and subsequent electronics, suited for applications up to <ul style="list-style-type: none"> <li>• SIL 2 as per EN 61508:2011 (further basis for testing: EN 61800-5-2)</li> <li>• Category 3, PL d as per EN ISO 13849-1:2016-06</li> </ul>
PFH	$26 \times 10^{-9}$ (with respect to an operating altitude of $\leq 1000$ m above sea level)
Safe position	Due to the connected encoder and the subsequent electronics (i.e. through the configuration); the EIB has no influence on the safe position
<b>Input</b>	
Interface	EnDat 2.2
Ordering designation	EnDat22 ( <i>Note the requirements on the encoder</i> )
Electrical connection	M12 connector (female), 8-pin
Encoder voltage supply (U <sub>P2</sub> )	DC 5.1 V $\pm$ 0.15 V, max. 2500 mW
Cable length	$\leq 100$ m <sup>1)</sup>
<b>Output</b>	
Interface	DRIVE-CLiQ
Ordering designation	DQ01
Electrical connection	M12 connector (male), 8-pin
Cable length	$\leq 95$ m <sup>2)</sup>
<b>Voltage supply</b> (U <sub>P1</sub> )	DC 24 V (16.0 V to 28.8 V) (up to DC 36.0 V possible without impairing functional safety)
Power consumption	<i>Maximum</i> At 16.0 V: $\leq 4.1$ W At 28.8 V: $\leq 4.35$ W <i>Typical</i> At 24 V: $1.1$ W + $1.15 \times P_{Mtyp}$ (with $P_{Mtyp}$ = typical power consumption of the encoder)
<b>Operating temperature</b>	0 °C to 60 °C
<b>Storage temperature</b>	-30 °C to 70 °C
<b>Vibration</b> 55 to 2000 Hz <b>Shock</b> 11 ms	100 m/s <sup>2</sup> (IEC 60068-2-6) 200 m/s <sup>2</sup> (IEC 60068-2-27)
<b>Protection</b> EN 60529	IP65
<b>Mass</b>	$\approx 180$ g

<sup>1)</sup> With HEIDENHAIN cable; note the power supply at the encoder.

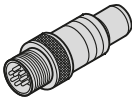

<sup>2)</sup> Depending on the output cable; the plug connection to the EIB is to be considered a DRIVE-CLiQ coupling.

# Interfaces

## Pin layout of the EIB input

<i>Mating connector</i> <b>8-pin coupling, M12</b>   								
	Power supply				Serial data transfer			
	<b>8</b>	<b>2</b>	<b>5</b>	<b>1</b>	<b>3</b>	<b>4</b>	<b>7</b>	<b>6</b>
<b>EnDat</b>	<b>U<sub>P2</sub></b>	<b>Sensor U<sub>P2</sub></b>	<b>0V</b>	<b>Sensor 0V</b>	<b>DATA</b>	<b>DATA</b>	<b>CLOCK</b>	<b>CLOCK</b>
	Brown/Green	Blue	White/Green	White	Gray	Pink	Violet	Yellow

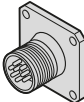
## Pin layout of the EIB output



<i>On the EIB 2391 S</i> <b>8-pin flange socket, M12</b>   								
	Power supply		Serial data transfer				Miscellaneous	
	<b>1</b>	<b>5</b>	<b>3</b>	<b>4</b>	<b>7</b>	<b>6</b>	<b>2</b>	<b>8</b>
<b>DRIVE-CLiQ</b>	<b>U<sub>P1</sub></b>	<b>0V</b>	<b>RXP</b>	<b>RXN</b>	<b>TXP</b>	<b>TXN</b>	/	/

**Cable shield** connected to housing; **U<sub>P</sub>** = Power supply voltage

**Sensor:** The sensor line is connected in the encoder with the corresponding voltage supply.

Vacant pins or wires must not be used.

## Connecting cables for DRIVE-CLiQ

<b>PUR</b> [2(2 x 0.17 mm <sup>2</sup> ) + (2 x 0.24 mm <sup>2</sup> )]; A <sub>P</sub> = 0.24 mm <sup>2</sup>			
<b>Complete</b> With M12 connector (female), 8-pin, and M12 coupling (male), 8-pin		∅ 6.8 mm	822504-xx
<b>Complete</b> With M12 connector (female), 8-pin, and Siemens RJ45 connector (IP67) Cable length: 1 m		∅ 6.8 mm	1094652-01
<b>Complete</b> With M12 connector (female), 8-pin, and Siemens RJ45 connector (IP20)		∅ 6.8 mm	1093042-xx

A<sub>P</sub>: Cross section of power supply lines

DRIVE-CLiQ is a registered trademark of Siemens Aktiengesellschaft

# HEIDENHAIN

**DR. JOHANNES HEIDENHAIN GmbH**

Dr.-Johannes-Heidenhain-Straße 5

**83301 Traunreut, Germany**

☎ +49 8669 31-0

FAX +49 8669 32-5061

E-mail: info@heidenhain.de

**www.heidenhain.de**

This Product Information supersedes all previous editions, which thereby become invalid. The basis for ordering from HEIDENHAIN is always the Product Information document edition valid when the order is made.



### For more information:

Comply with the requirements described in the following documents to ensure the correct operation of the encoder:

- Brochure, Product Information and Mounting Instructions of the connected encoder
- Technical Information: *Safety-Related Position Measuring Systems* 596632
- Mounting Instructions *EIB 2391 S* 895532

Applicable for implementation in a control or inverter:

- Data of the subsequent electronics manufacturer for use of the EIB 2391 S in safety-related applications